

## IGBT Module

Short Circuit SOA Capability  
Square RBSOA

### PSII 100/12\*

$I_{C80} = 90 \text{ A}$   
 $V_{CES} = 1200 \text{ V}$   
 $V_{CE(sat)typ.} = 2.8 \text{ V}$

Preliminary Data Sheet

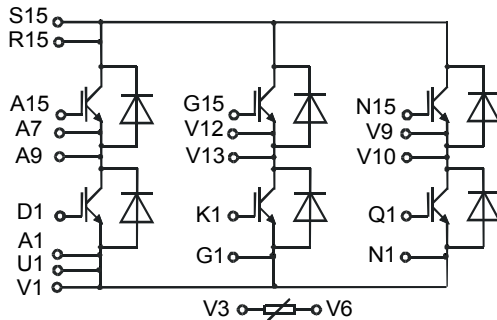

ECO-TOP™ 1

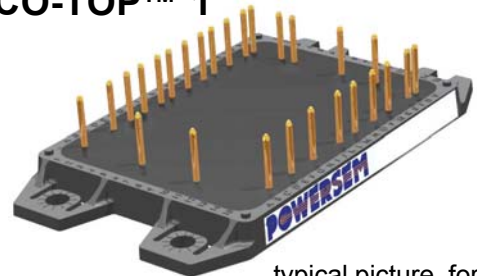

typical picture, for pin configuration see outline drawing

## IGBTs

Symbol	Conditions	Maximum Ratings	
$V_{CES}$	$T_{VJ} = 25^\circ\text{C to } 150^\circ\text{C}$	1200	V
$V_{GES}$		$\pm 20$	V
$I_{C25}$	$T_C = 25^\circ\text{C}$	130	A
$I_{C80}$	$T_C = 80^\circ\text{C}$	90	A
$I_{CM}$ $V_{CEK}$	$V_{GE} = \pm 15 \text{ V}; R_G = 15 \Omega; T_{VJ} = 125^\circ\text{C}$ RBSOA, Clamped inductive load; $L = 100 \mu\text{H}$	150	A
		$V_{CES}$	
$t_{SC}$ (SCSOA)	$V_{CE} = V_{CES}; V_{GE} = \pm 15 \text{ V}; R_G = 15 \Omega; T_{VJ} = 125^\circ\text{C}$ non-repetitive	10	$\mu\text{s}$
$P_{tot}$	$T_C = 25^\circ\text{C}$	568	W

\*NTC optional

Symbol	Conditions	Characteristic Values ( $T_{VJ} = 25^\circ\text{C}$ , unless otherwise specified)		
		min.	typ.	max.
$V_{CE(sat)}$	$I_C = 125 \text{ A}; V_{GE} = 15 \text{ V}; T_{VJ} = 25^\circ\text{C}$ $T_{VJ} = 125^\circ\text{C}$	2.8	3.4	V
		3.2		V
$V_{GE(th)}$	$I_C = 3 \text{ mA}; V_{GE} = V_{CE}$	4.5		V
$I_{CES}$	$V_{CE} = V_{CES}; V_{GE} = 0 \text{ V}; T_{VJ} = 25^\circ\text{C}$ $T_{VJ} = 125^\circ\text{C}$		5	mA
			16	mA
$I_{GES}$	$V_{CE} = 0 \text{ V}; V_{GE} = \pm 20 \text{ V}$		320	nA
$t_{d(on)}$	Inductive load, $T_{VJ} = 125^\circ\text{C}$ $V_{CE} = 600 \text{ V}; I_C = 75 \text{ A}$ $V_{GE} = 15/0 \text{ V}; R_G = 15 \Omega$	100		ns
$t_r$		50		ns
$t_{d(off)}$		650		ns
$t_f$		50		ns
$E_{on}$		12.1		mJ
$E_{off}$		10.5		mJ
$C_{ies}$	$V_{CE} = 25 \text{ V}; V_{GE} = 0 \text{ V}; f = 1 \text{ MHz}$	5.5		nF
$R_{thJC}$	(per IGBT)		0.22	K/W
$R_{thJH}$	with heatsink compound ( $0.42 \text{ K/m.K}; 50 \mu\text{m}$ )	0.44		K/W

## Features

- Package with DCB ceramic base plate
- Isolation voltage 3000 V~
- Planar glass passivated chips
- Low forward voltage drop
- Leads suitable for PC board soldering
- UL Release applied

## Applications

- AC and DC motor control
- AC servo and robot drives
- Power supplies
- Welding inverters

## Advantages

- Easy to mount with four screws
- Space and weight savings
- Improved temperature and power cycling capability
- High power density
- Small and light weight

**Caution:** These Devices are sensitive to electrostatic discharge. Users should observe proper ESD handling precautions.

## Reverse diodes (FRED)

Symbol	Conditions	Maximum Ratings	
$I_{F25}$	$T_C = 25^\circ\text{C}$	150	A
$I_{F80}$	$T_C = 80^\circ\text{C}$	100	A

Symbol	Conditions	Characteristic Values		
		min.	typ.	max.
$V_F$	$I_F = 75\text{ A}; T_{VJ} = 25^\circ\text{C}$ $T_{VJ} = 125^\circ\text{C}$	2.2	2.5	V
		1.6		V
$I_{RM}$ $t_{rr}$	$I_F = 75\text{ A}; di_F/dt = 750\text{ A}/\mu\text{s}; T_{VJ} = 125^\circ\text{C}$ $V_R = 600\text{ V}; V_{GE} = 0\text{ V}$	79		A
		220		ns
$R_{thJC}$ $R_{thJH}$	with heatsink compound (0.42 K/m.K; 50 $\mu\text{m}$ )	0.9		0.45 K/W K/W

## Temperature Sensor NTC

Symbol	Conditions	Characteristic Values		
		min.	typ.	max.
$R_{25}$	$T = 25^\circ\text{C}$	4.75	5.0	5.25 k $\Omega$
$B_{25/50}$			3375	K

## Module

Symbol	Conditions	Maximum Ratings	
$T_{VJ}$		-40...+125	$^\circ\text{C}$
$T_{stg}$		-40...+150	$^\circ\text{C}$
$V_{ISOL}$	$I_{ISOL} \leq 1\text{ mA}; 50/60\text{ Hz}$	3000	V~
$M_d$	Mounting torque (M5)	3	Nm
		26	lb.in.
$a$	Max. allowable acceleration	50	$\text{m/s}^2$

Symbol	Conditions	Characteristic Values		
		min.	typ.	max.
$d_s$	Creepage distance on surface (Pin to heatsink)	11.2		mm
$d_A$	Strike distance in air (Pin to heatsink)	11.2		mm
<b>Weight</b>		86		g

## Package style and outline

Dimensions in mm (1mm = 0.0394")

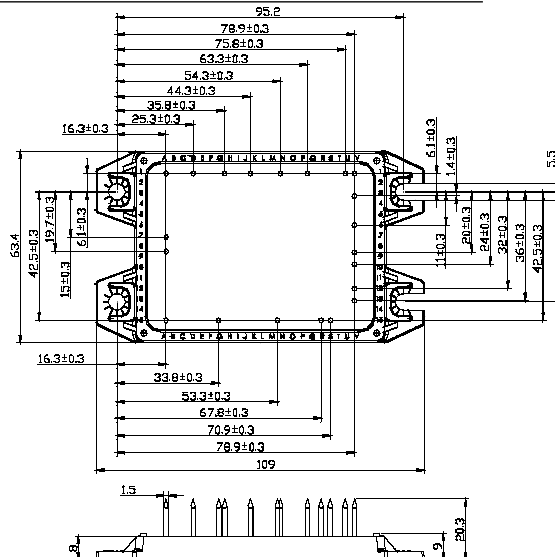

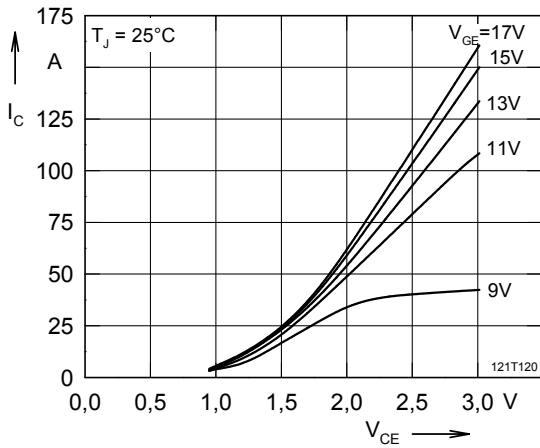

Fig. 1 Typ. output characteristics

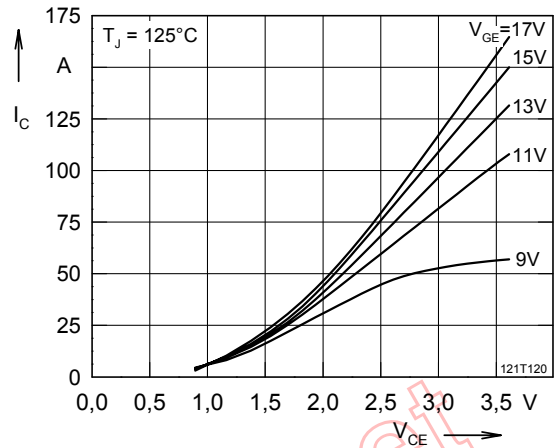

Fig. 2 Typ. output characteristics

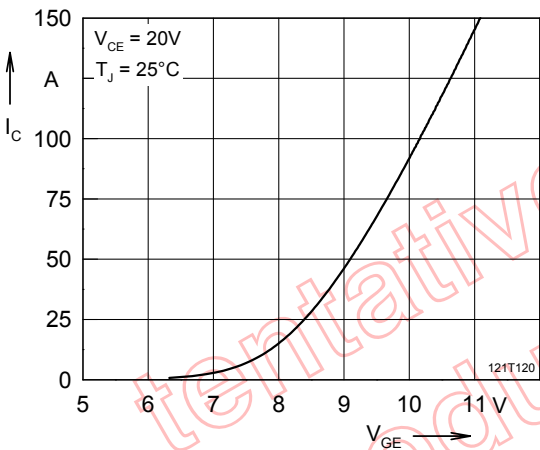

Fig. 3 Typ. transfer characteristics

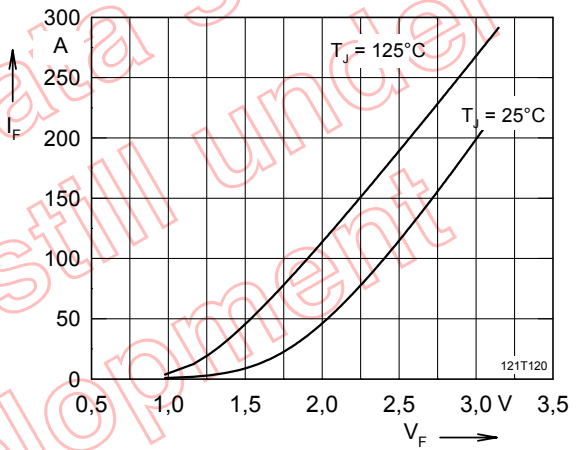

Fig. 4 Typ. forward characteristics of free wheeling diode

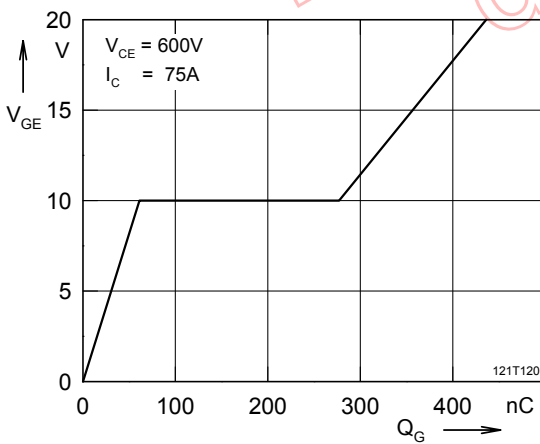

Fig. 5 Typ. turn on gate charge

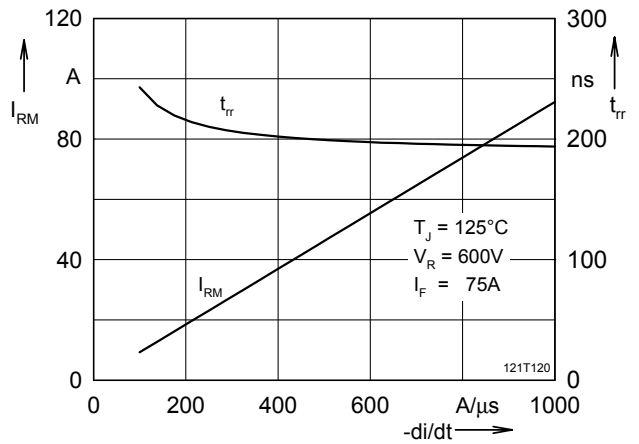

Fig. 6 Typ. turn off characteristics of free wheeling diode

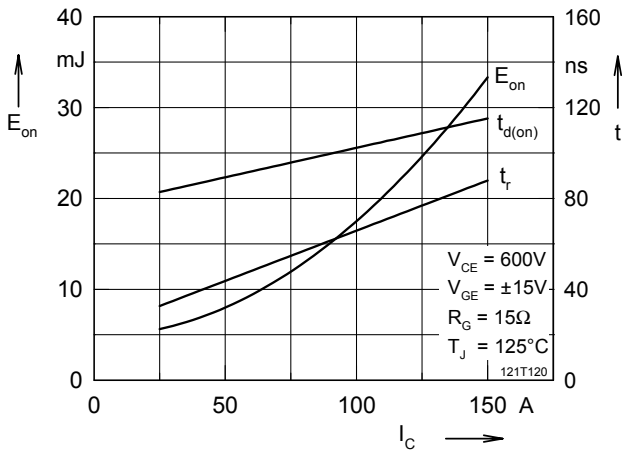

Fig. 7 Typ. turn on energy and switching times versus collector current

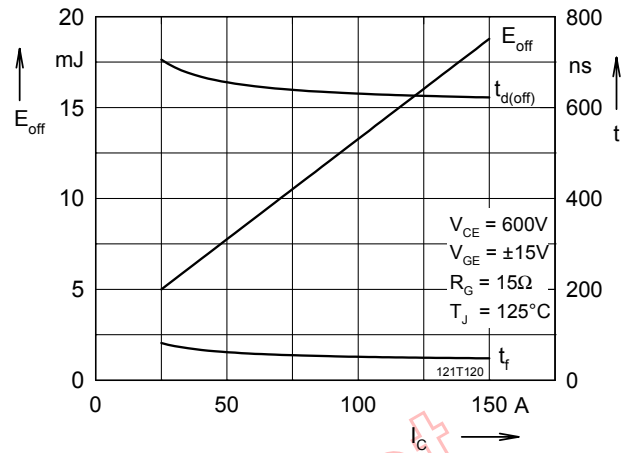

Fig. 8 Typ. turn off energy and switching times versus collector current

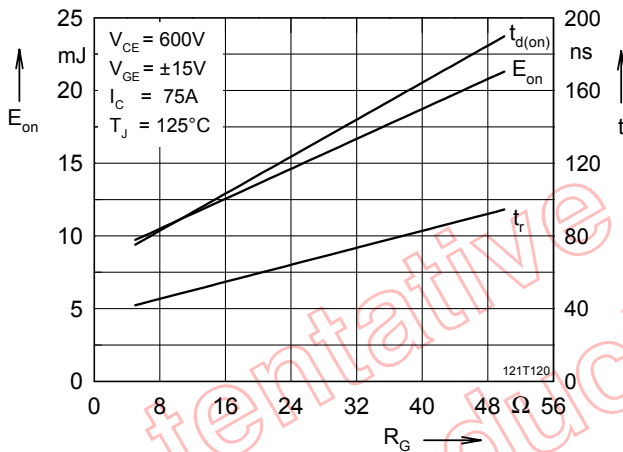

Fig. 9 Typ. turn on energy and switching times versus gate resistor

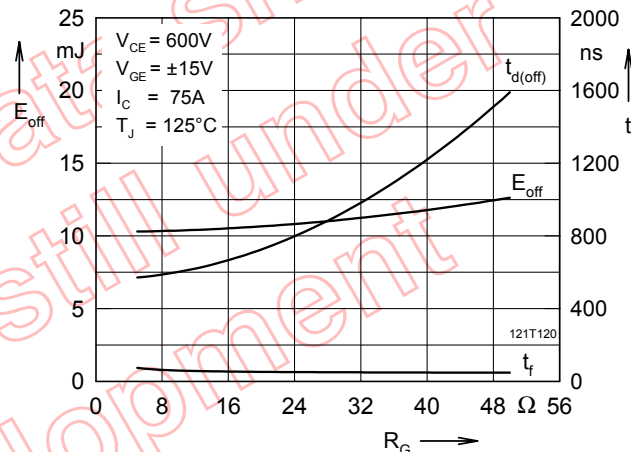

Fig. 10 Typ. turn off energy and switching times versus gate resistor

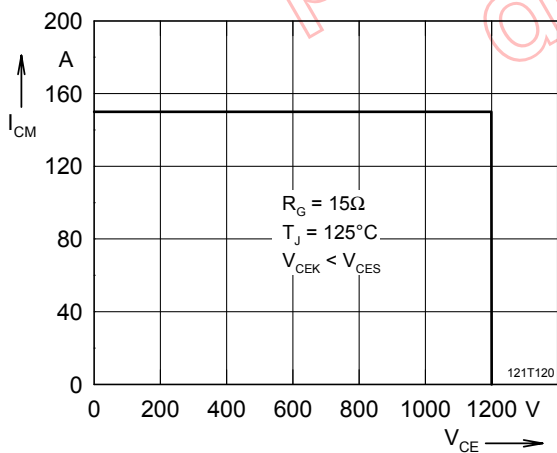

Fig. 11 Reverse biased safe operating area RBSOA

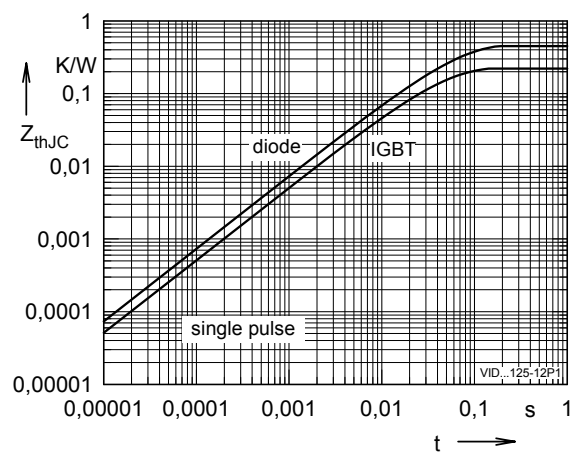

Fig. 12 Typ. transient thermal impedance