

Diode modules

PSKD 162M

$I_{F(AV)} = 160 \text{ A}$
 $V_{RRM} = 800-1800 \text{ V}$

Preliminary Data Sheet

V_{RSM} V	V_{RRM} V	Type
900	800	PSKD 162M/08
1100	1000	PSKD 162M/10
1300	1200	PSKD 162M/12
1500	1400	PSKD 162M/14
1700	1600	PSKD 162M/16
1900	1800	PSKD 162M/18

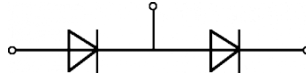

Symbol	Test Conditions	Maximum Ratings
$I_{F(AV)}$	$T_C = 100^\circ\text{C}$, module	160 A
$I_{F(RMS)}$		251 A
I_{FSM}	$T_{VJ} = 150^\circ\text{C}$ t = 10 ms half sine	4600 A
$\int i^2 dt$	$T_{VJ} = 150^\circ\text{C}$ t = 10 ms half sine	106 $\text{A}^2 \text{s} \cdot 10^3$
T_{VJ}		-40 ... + 150 $^\circ\text{C}$
T_{VJM}		150 $^\circ\text{C}$
T_{stg}		-40 ... + 125 $^\circ\text{C}$
V_{ISOL}	50 Hz, RMS t = 1 min $I_{ISOL} \leq 1 \text{ mA}$	min. 3000 V ~
M_d	Mounting torque (M6)	6,0 Nm
	Terminal connection torque (M5)	4,0 Nm
Weight	typ.	285 g

Features

- Isolated mounting base 3000V~
- Pressure contact technology with increased power cycling capability

Applications

- AC/DC Motor drives
- Various rectifiers
- DC supply for PWM inverter

Advantages

- Easy to mount
- Space and weight savings
- Improved temperature and power cycling capability

Package, style and outline

Dimensions in mm (1mm = 0.0394")

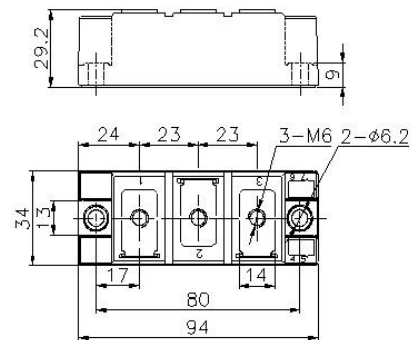

Symbol	Test Conditions	Characteristic Value
I_{RRM}	at V_{RRM} $T_{VJ} = 150^\circ\text{C}$	$\leq 12 \text{ mA}$
V_{FM}	$I_{FM} = 480 \text{ A}$ $T_{VJ} = 25^\circ\text{C}$	$\leq 1,56 \text{ V}$
V_{FO}	For power-loss calculations only	0,8 V
r_f	$T_{VJ} = T_{VJM}$	1,35 $\text{m}\Omega$
$R_{th(j-c)}$	Per chip; Single side cooled	0,23 $^\circ\text{C/W}$