

Single Phase Rectifier Bridges

PSBS 82

$I_{dAVM} = 72A$
 $V_{RRM} = 800-1800 V$

Preliminary Data Sheet

V_{RSM} V	V_{RRM} V	Type
800	800	PSBS 82/08
1200	1200	PSBS 82/12
1400	1400	PSBS 82/14
1600	1600	PSBS 82/16
1800	1800	PSBS 82/18

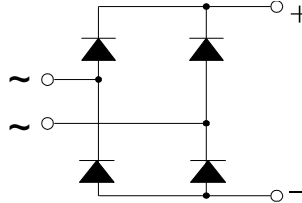

Symbol	Test Conditions	Maximum Ratings
I_{dAVM}	$T_C = 100^\circ C$, module	72 A
I_{FSM}	$T_{VJ} = 45^\circ C$ $t = 10$ ms (50 Hz), sine	750 A
	$V_R = 0$ $t = 8.3$ ms (60 Hz), sine	820 A
	$T_{VJ} = T_{VJM}$ $t = 10$ ms (50 Hz), sine	670 A
	$V_R = 0$ $t = 8.3$ ms (60 Hz), sine	740 A
$\int i^2 dt$	$T_{VJ} = 45^\circ C$ $t = 10$ ms (50 Hz), sine	2800 A ² s
	$V_R = 0$ $t = 8.3$ ms (60 Hz), sine	2800 A ² s
	$T_{VJ} = T_{VJM}$ $t = 10$ ms (50 Hz), sine	2250 A ² s
	$V_R = 0$ $t = 8.3$ ms (60 Hz), sine	2250 A ² s
T_{VJ}		-40 ... + 150 °C
T_{VJM}		150 °C
T_{stg}		-40 ... + 125 °C
V_{ISOL}	50/60 HZ, RMS $t = 1$ min	2500 V ~
	$I_{ISOL} \leq 1$ mA $t = 1$ s	3000 V ~
M_d	Mounting torque (M5)	5 Nm
	Terminal connection torque (M5)	5 Nm
Weight	typ.	120 g

Features

- Low profile (overall height: 17 mm)
- Package with screw terminals
- Isolation voltage 3000 V~
- Planar glasspassivated chips
- Blocking voltage up to 1800 V
- Low forward voltage drop
- UL release applied, RoHS conform

Applications

- Supplies for DC power equipment
- Input rectifiers for PWM inverter
- Battery DC power supplies
- Field supply for DC motors

Advantages

- Easy to mount with two screws
- Space and weight savings
- Improved temperature and power cycling capability

Package, style and outline

Dimensions in mm (1mm = 0.0394")

Max. allowed screw-in depth: 8.5 mm !

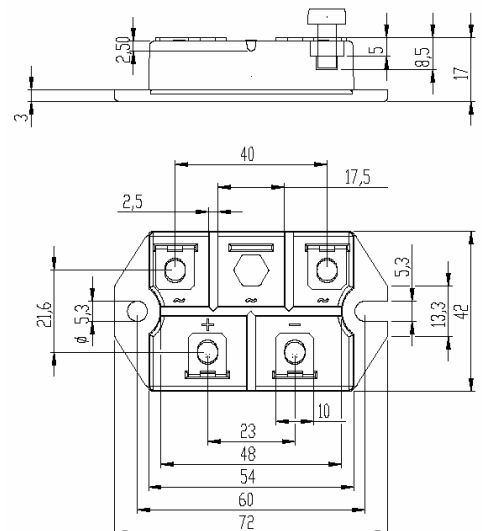

Symbol	Test Conditions	Characteristic Value
I_R	$V_R = V_{RRM}$ $T_{VJ} = 25^\circ C$	≤ 0.3 mA
	$V_R = V_{RRM}$ $T_{VJ} = T_{VJM}$	≤ 5 mA
V_F	$I_F = 150$ A $T_{VJ} = 25^\circ C$	≤ 1.6 V
V_{TO}	For power-loss calculations only	0.8 V
r_T	$T_{VJ} = T_{VJM}$	5 mΩ
R_{thJC}	per diode; DC current	1.1 K/W
	per module	0.28 K/W
R_{thJK}	per diode; DC current	1.52 K/W
	per module	0.38 K/W
d_s	Creeping distance on surface	10 mm
d_A	Creeping distance in air	9.4 mm
a	Max. allowable acceleration	50 m/s ²

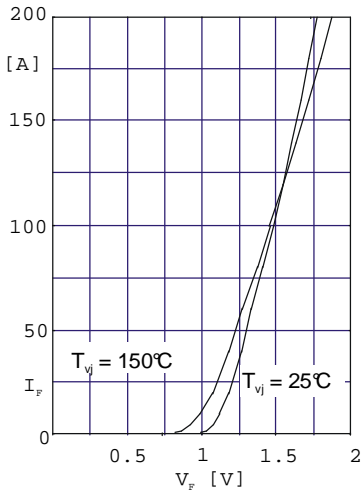

Fig. 1 Forward current versus voltage drop per diode

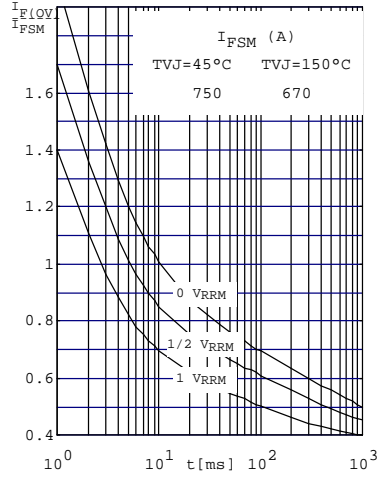

Fig. 2 Surge overload current per diode I_{FSM} : Crest value. t : duration

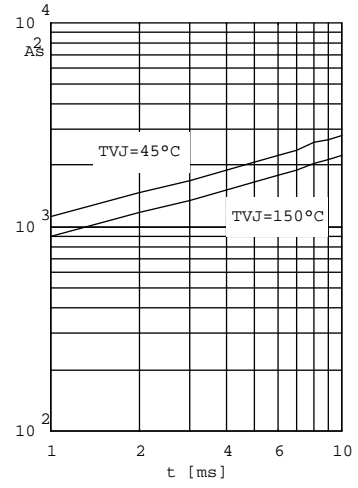

Fig. 3 $\int i^2 dt$ versus time (1-10ms) per diode (or thyristor)

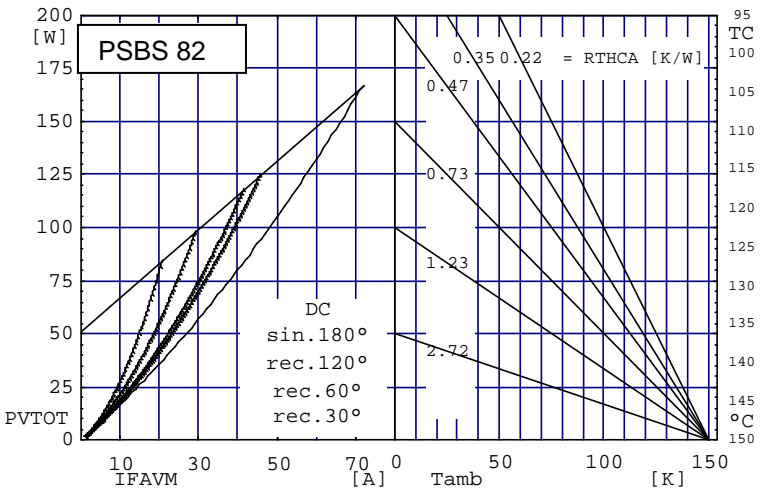

Fig. 4 Power dissipation versus direct output current and ambient temperature

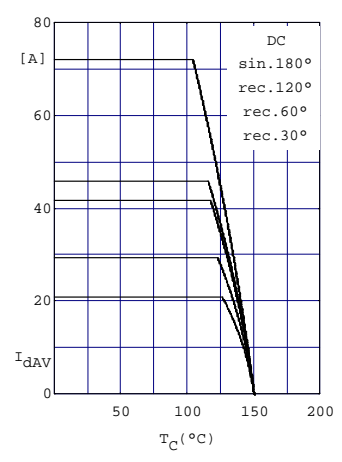

Fig. 5 Maximum forward current at case temperature

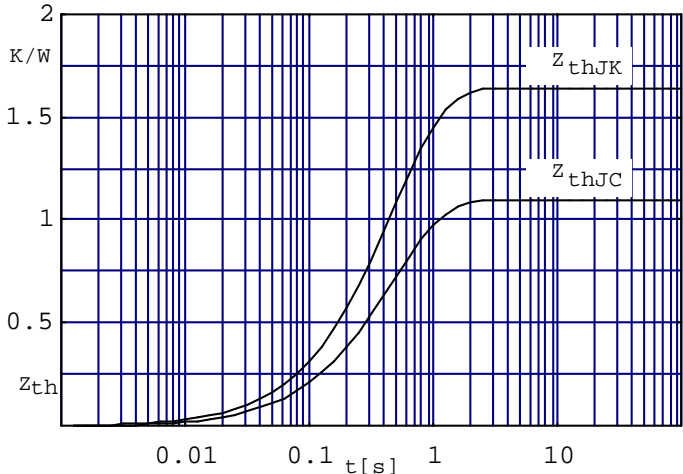

Fig. 6 Transient thermal impedance per diode (or thyristor), calculated